

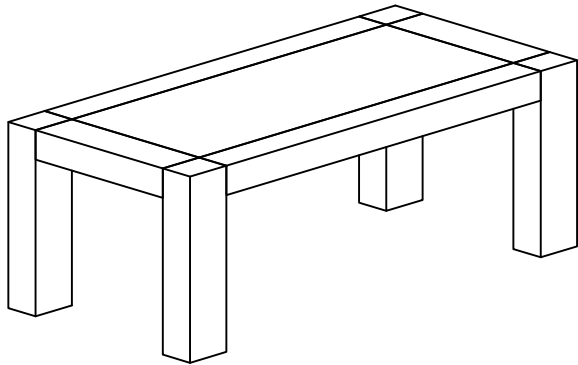







ASSEMBLY INSTRUCTION

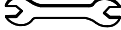

NO.:	HARDWARE LIST	Q'TY
A		4
B		4
C		4
D		1
E		6
F		6
G		1

